

# LFX-LG SERIES Outdoor Lighting

LFX-LG-50-150W-30K  
LFX-LG-50-150W-40K  
LFX-LG-50-150W-50K

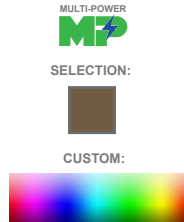

Customer Name: \_\_\_\_\_  
Project Name: \_\_\_\_\_  
Note: \_\_\_\_\_ | Type: \_\_\_\_\_

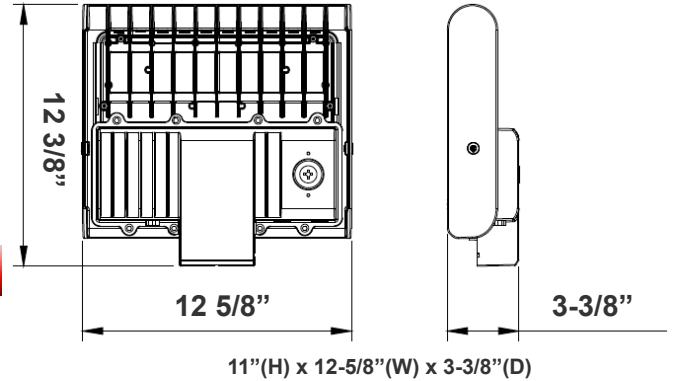

Ideal for general site lighting, alleys, loading docks, doorway, pathway, and parking areas.

## Features

- DLC Premium & LED High-Lumen Flood lights
- Solid State Lighting Technology for Long Life
- No Maintenance Needed and High-Efficiency
- 70,000 Hours Rated Life
- 7-Year Warranty
- Optic Lens Type: III
- Multi-Power - The Switch is On the Bottom of the Fixture

## Technical Specifications

### Electrical:

- Voltage: 120~277V AC/50~60 Hz
- Wattage: 50/ 80/ 100/ 150W
- Power Factor: >0.9
- Efficacy: 140 LPW

### Mechanical:

- With Snap-on & Bolt Mounting Options for One- Person Installations. Select a Mounting Option (Sold Separately)
- LED: Philips Lumileds Luxeon 2835 High Flux LED
- Die-cast Aluminum Housing with Powder Coat Finish (Dark Bronze)
- IP Rating: IP65
- Effective Projected Areas (EPA's) are: Front = 0.38 ft<sup>2</sup>, Side = 0.30 ft<sup>2</sup>, Face = 1.05 ft<sup>2</sup>
- Operating Temperature: -40°F to 104°F
- Suitable for Wet Locations

### Lighting:

- Dimming: 0~10V dimmable
- Optic Lens Type: III
- Cord Type: 6' SJTW 18/3 AWG cable
- Total Lumens: 21400LM Max.
- Color Temperature: 3000K/ 4000K/ 5000K
- Color Rendering Index: ≥ 82
- Beam Angle: 120°X 90°

### Applications:

- Ideal for general site lighting, alleys, loading docks, doorway, pathway and parking areas.
- Replace existing HID flood lights/ wall packs

### Other Models:

- 300W | 44000LM | LFX-XL-150-300W-30K
- 300W | 44000LM | LFX-XL-150-300W-40K
- 300W | 44000LM | LFX-XL-150-300W-50K



## Photometrics: LFX-LG-50-150W

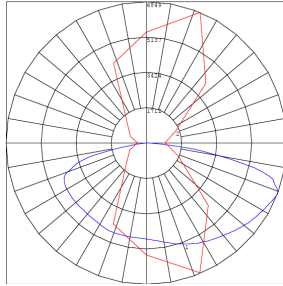
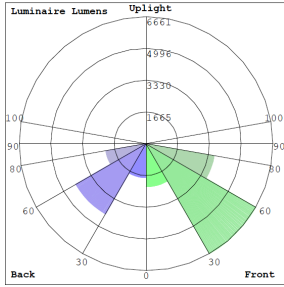

BUG Rating: B3-U0-G3

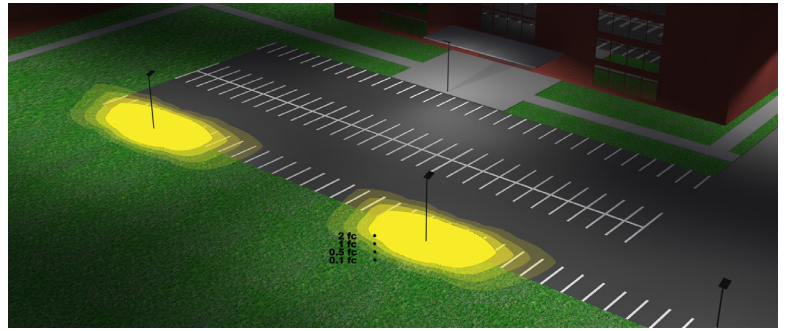

Area 55'x 100' Mounting Height: 20'

## Other Views:



Side View



Front View



Back View

## Performance Table: LFX-LG-50-150W

MODEL NO.	Wattage	Voltage	Lumens	Color Temp.	BUG Rating	LPW
LFX-LG-50-150W-30K	50W	120~277V	8500LM	3000K 4000K 5000K	B3-U0-G3	140
			8750LM			
			8850LM			
12900LM						
LFX-LG-50-150W-40K	80W		13200LM			
			13400LM			
			15500LM			
LFX-LG-50-150W-50K	100W		16000LM			
			16150LM			
		20850LM				
LFX-LG-50-150W-50K	150W	21300LM				
		21400LM				
		21400LM				

## Example:

1. LFX-LG-50-150W-50K

(For LFX 150W 5000K fixture 120-277V)

2. LFX-LG-50-150W-50K  
WEC-8RC

(For LFX 150W 5000K fixture 120-277V)  
(For Remote Control)

3. LFX-LG-50-150W-50K  
WEC-8RC  
OPT-SEN-3MR-3

(For LFX 150W 5000K fixture 120-277V)  
(For Remote Control)  
(For Programmable Microwave BI-Level Motion Sensor)

**WESTGATE**

Phone: (877) 805-2252 | Fax: (877) 805-2252  
www.westgatemfg.com | www.westgatecontrols.co



# Sample Ordering

**Model    Size    Min.Wattage    Max.Wattage    Color Temp.**

LFX - LG - 50 - 150W -

30K = 3000K  
40K = 4000K  
50K = 5000K

## Accessories Options

Blank = No Option for Accessories  
WEC-8RC = Remote Control for OPT-SEN-3MR-4  
\*REFER TO PAGE 3 FOR MOUNTING OPTIONS

## Factory Installed Options

Blank = No Factory Installed Options  
OPT-LF3-PCK = Twist Lock Photocell  
OPT-SEN-3MR-3 = Programmable Microwave Bi-Level  
OPT-TLSOC7P = 7-Pin Receptacle Kit to accept Smart Control Twist-Lock Photocell (Photocell not incl.) (Shorting Cap incl.)  
OPT-CLR-95 = Color Paint

## SENSOR AND REMOTE CONTROL OPTIONS



LF3-HL-PCK  
Twist-Lock  
Photocell + Receptacle Kit



OPT-SEN-3MR-3  
Bi-Level Motion  
Sensor



WEC-8RC  
Remote control



OPT-TLSOC7P  
Smart Control  
7-Pin Receptacle Kit  
(Photocell not incl.)  
(Shorting Cap incl.)



Smart Control  
7-Pin Receptacle Kit  
for  
OPT-TLSOC7P

## Mounting Options:

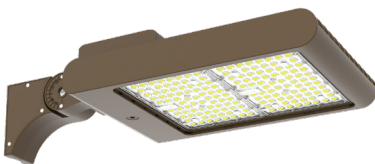

LFX-ASA  
Adjustable Straight Arm  
3 1/3" x 7 7/8"

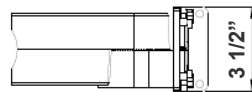
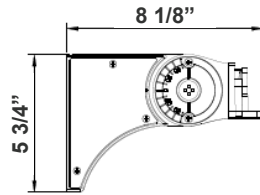

LFX-YK  
Yoke  
5 3/4" x 6" x 2"

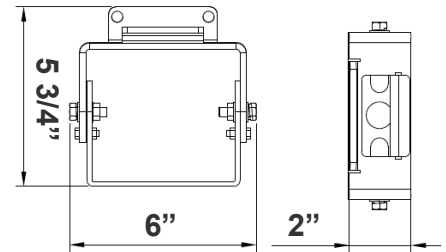

LFX-EXT  
Straight Arm  
3 1/3" x 6 3/4" x 4 3/8"

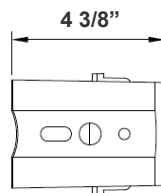
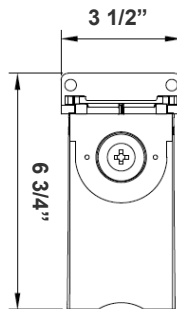

LFX-TR-A  
U Bracket  
13 3/8" x 10 1/8"

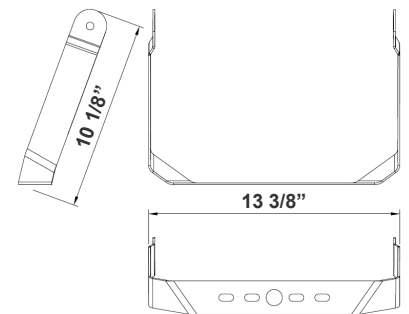

LFX-SF  
Slip Fitter  
3 1/3" x 7 7/8"

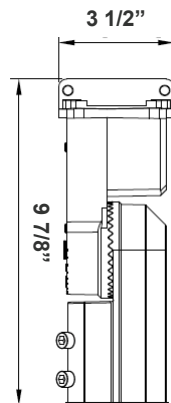

LFX-SF + LFX-PASF  
Pole Adapter for Slip Fitter  
6 1/8" x 3 1/4" x 3"

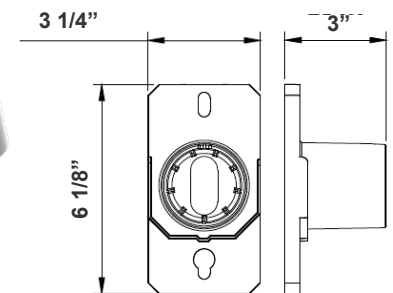

**Color Options:** LFX-LG-50-150W  
 Custom Color Available

Black   Silver   White   **Dark Bronze**   Green   Red   Yellow  
Default color



**Shroud & Wire Guard:** LFX-LG-50-150W



**LF-SHROUD-A**  
 Shroud  
 6 1/8" x 10 5/8" x 4 3/4"

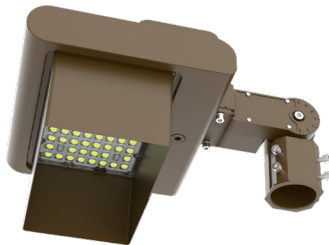
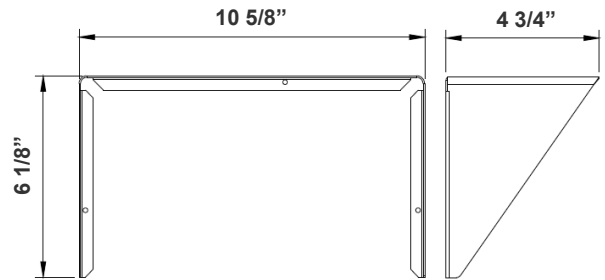

**LF-SHROUD-D**  
 Full-Glare Shroud  
 6 1/4" x 10 5/8" x 4 3/4"

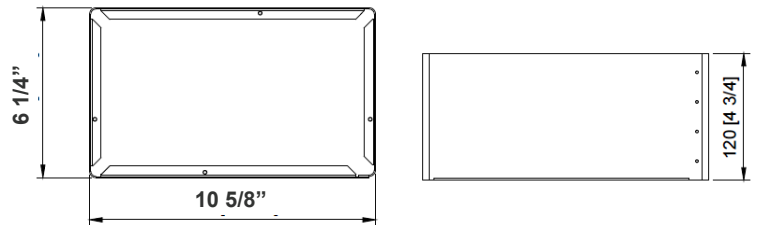

**LFX-WG-A**  
 Wire Guard

